

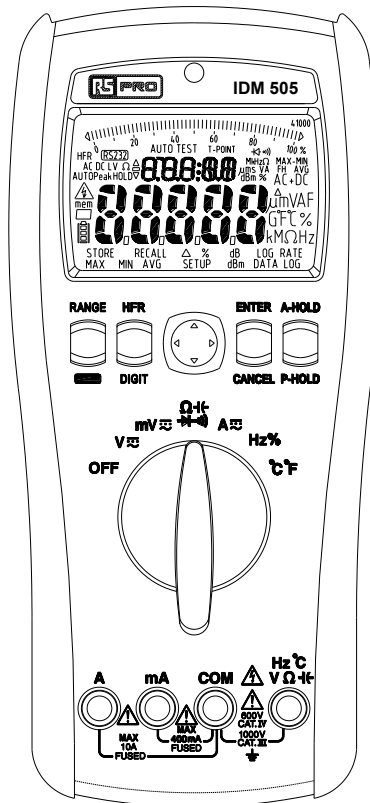

Instruction Manual IDM 503 & IDM 505 Digital Multimeters

EN



SECTION 1 –SAFETY INFORMATION

Safety Information

Understand and follow operating instructions carefully.

Use the Instrument only as specified in this manual; otherwise, the protection provided by the Instrument may be impaired.

WARNING

Identifies hazardous conditions and actions that could cause **BODILY HARM** or **DEATH**



CAUTION

Identifies conditions and actions that could **DAMAGE** the Instrument or equipment under test











WARNING

- Examine the instrument and probes before use. Do not use the instrument if it is wet or damaged
- When using test leads or probes, keep your fingers behind the finger guards.
- Remove the test lead from the instrument before opening the battery cover or instrument case.
- Always use the correct terminals, switch position and range for measurements.
- Never attempt a voltage measurement with the test leads inserted into the “A”input terminals.
- Verify the instrument is operating correctly by measuring a known voltage before use. If in doubt, have the instrument serviced.
- Do not apply more than the rated voltage, as marked on the instrument, between terminals or between any terminal and earth ground.
- Do not attempt a current measurement when the open-circuit voltage is above the fuse protection rating.
- Only replace a fuse with the correct type and rating as specified in this instruction manual.
- Use caution when measuring voltages above 30 Vac rms, 42 Vac peak or 60 Vdc. These voltages pose a shock hazard.
- To avoid false readings that can lead to electric shock, replace the battery as soon as the low battery indicator appears in the display.
- Disconnect the circuit power and discharge all high-voltage capacitors before making resistance, current, continuity, diode or capacitance measurements.
- Do not use the instrument in a hazardous area or around explosive gasses or vapours.
- Wear suitable personal protective equipment when working around or near hazardous live conductors which could be accessible.

CAUTION

- Disconnect the test leads from the test points before changing the position of the function rotary switch.
- Never connect a source of voltage with the function rotary switch in the “Ω”, “”, “°C”, “mA”, or “A” position.
- Do not expose the instrument to extremes in temperature or high humidity.
- Never set the instrument in the “Ω”, “”, “°C”, “mA”, or “A” position to measure the voltage of a circuit, this could result in damage the instrument and the equipment under test.

Symbols as marked on the instrument and instruction manual

	Risk of electric shock
	See instruction manual
	DC measurement
	Equipment protected by double or reinforced Insulation
	Battery
	Fuse
	Earth
	AC measurement
	Conforms to EU directives
	Dispose of in accordance with local regulations.

Maintenance

Do not attempt to repair this instrument. It contains no user serviceable parts. Repair or servicing should only be performed by qualified personnel.

IDM 503 / 505 English

Unsafe Voltage

To alert you to the presence of a potentially hazardous voltage when the rotary switch is in V or mV position symbols are displayed as detailed in the table below:

Hazardous voltage in 503

IDM503						
Function	Range	Input	Mode			
			Auto Test	AC	DC	AC+DC
mV	40.00mV	0 - 40mVac	Reading	Reading	N/A	Reading
		>40mVac	–	OL	N/A	OL
		0 - 40mVdc	Reading	N/A	Reading	Reading
		>40mVdc	–	N/A	OL	OL
	400.0mV	0 - 40mVac	–	Reading	N/A	Reading
		40 - 400mVac	Reading	Reading	N/A	Reading
		>400mVac	OL	OL	N/A	OL
		0 - 40mVdc	–	N/A	Reading	Reading
		40 - 400mVdc	Reading	N/A	Reading	Reading
		>400mVdc	OL	N/A	OL	OL
V	4.000V	0 - 4Vac	Reading	Reading	N/A	Reading
		>4Vac	–	OL	N/A	OL
		0 - 4Vdc	Reading	N/A	Reading	Reading
		>4Vdc	–	N/A	OL	OL
	40.00V	0 - 4Vac	–	Reading	N/A	Reading
		4 - 30Vac	Reading	Reading	N/A	Reading
		30 - 40Vac	Reading	Reading	N/A	Reading
		>40Vac	–	OL	N/A	OL
		0 - 4Vdc	–	N/A	Reading	Reading
		4 - 30Vdc	Reading	N/A	Reading	Reading
		30 - 40Vdc	Reading	N/A	Reading	Reading
		>40Vdc	–	N/A	OL	OL
	400.0V	0 - 30Vac	–	Reading	N/A	Reading
		30 - 40Vac	–	Reading	N/A	Reading
		40 - 400Vac	Reading	Reading	N/A	Reading
		>400Vac	–	OL	N/A	OL
		0 - 30Vdc	–	N/A	Reading	Reading
		30 - 40Vdc	–	N/A	Reading	Reading
		40 - 60Vdc	Reading	N/A	Reading	Reading
		60 - 400Vdc	Reading	N/A	Reading	Reading
	>400Vdc	–	N/A	OL	OL	
	1000V	0 - 30Vac	–	Reading	N/A	Reading
		30 - 400Vac	–	Reading	N/A	Reading
		400 - 1000Vac	Reading	Reading	N/A	Reading
		>1000Vac	OL	OL	N/A	OL
		0 - 30Vdc	–	N/A	Reading	Reading
		30 - 60Vdc	–	N/A	Reading	Reading
		60 - 400Vdc	–	N/A	Reading	Reading
		400 - 1000Vdc	Reading	N/A	Reading	Reading
	>1000Vdc	OL	N/A	OL	OL	

Hazardous voltage in 505

IDM505							
Function	Range	Input	Mode				
			Auto Test	AC	DC	AC+DC	
mV	100.00mV	0 - 100mVac	Reading	Reading	N/A	Reading	
		>100mVac	-	OL	N/A	OL	
		0 - 100mVdc	Reading	N/A	Reading	Reading	
		>100mVdc	-	N/A	OL	OL	
	1000.0mV	0 - 100mVac	-	Reading	N/A	Reading	
		100 - 1000mVac	Reading	Reading	N/A	Reading	
		>1000mVac	OL	OL	N/A	OL	
		0 - 100mVdc	-	N/A	Reading	Reading	
		100 - 1000mVdc	Reading	N/A	Reading	Reading	
		>1000mVdc	OL	N/A	OL	OL	
	V	10.000V	0 - 10Vac	Reading	Reading	N/A	Reading
			>10Vac	-	OL	N/A	OL
0 - 10Vdc			Reading	N/A	Reading	Reading	
>10Vdc			-	N/A	OL	OL	
100.00V		0 - 10Vac	-	Reading	N/A	Reading	
		10 - 30Vac	Reading	Reading	N/A	Reading	
		30 - 100Vac	Reading	Reading	N/A	Reading	
		>100Vac	-	OL	N/A	OL	
		0 - 10Vdc	-	N/A	Reading	Reading	
		10 - 30Vdc	Reading	N/A	Reading	Reading	
		30 - 60Vdc	Reading	N/A	Reading	Reading	
		60 - 100Vdc	Reading	N/A	Reading	Reading	
>100Vdc		-	N/A	OL	OL		
1000.0V		0 - 30Vac	-	Reading	N/A	Reading	
		30 - 100Vac	-	Reading	N/A	Reading	
		100 - 1000Vac	Reading	Reading	N/A	Reading	
		>1000Vac	OL	OL	N/A	OL	
		0 - 30Vdc	-	N/A	Reading	Reading	
		30 - 60Vdc	-	N/A	Reading	Reading	
		60 - 100Vdc	-	N/A	Reading	Reading	
		100 - 1000Vdc	Reading	N/A	Reading	Reading	
>1000Vdc		OL	N/A	OL	OL		

Note: This symbol “-” indicates that the measurement does not show in the display.
 The symbol “N/A” indicates that the measurement is unspecified.

Cleaning

Periodically wipe the case with a dry cloth and detergent.
Do not use abrasives or solvents.

SECTION 2 - METER DESCRIPTION

Instrument Description

Front Panel Illustration

1. LCD display : 4000/40000 counts for IDM503.
10000/100000 counts for IDM505.
2. Push-buttons.
3. Rotary switch to turn the power on or off and to select a function.
4. Input Terminal for "A" (current measurement)
5. Input Terminal for "V", " Ω ", " μ ", Hz, and $^{\circ}$ C functions.
6. Common (ground reference) input terminal.
7. Input terminal for mA current measurement.

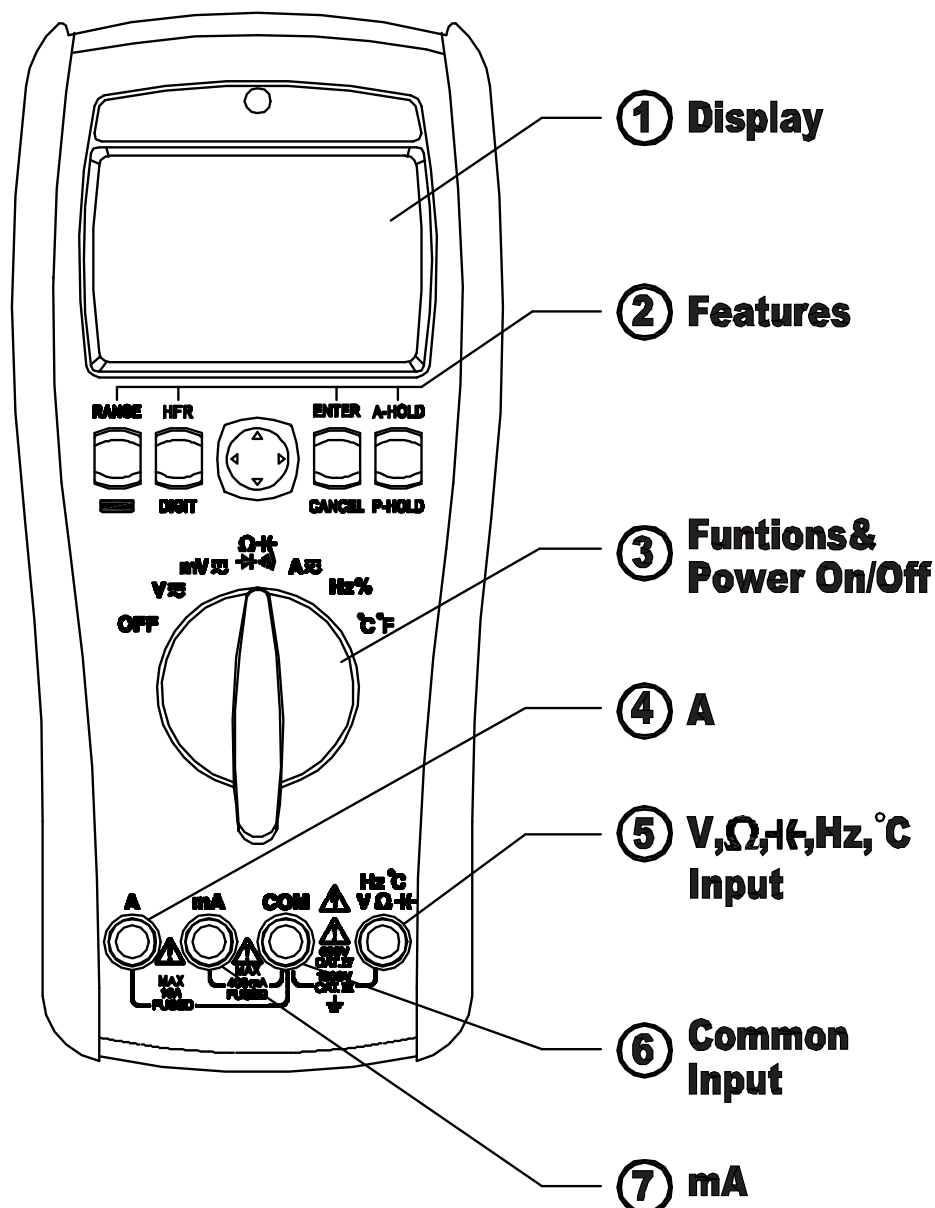

Making Basic Measurements

SECTION 3 – METER DESCRIPTION

Preparation and caution before measurement

⚠ Observe all warnings and cautions

When connecting the test leads to the device under test connect the common test lead before connecting the live lead ; when removing the test leads remove the test live lead before removing the common test lead.

The figures on the following pages show how to make basic measurements.

Measuring AC / DC Voltage

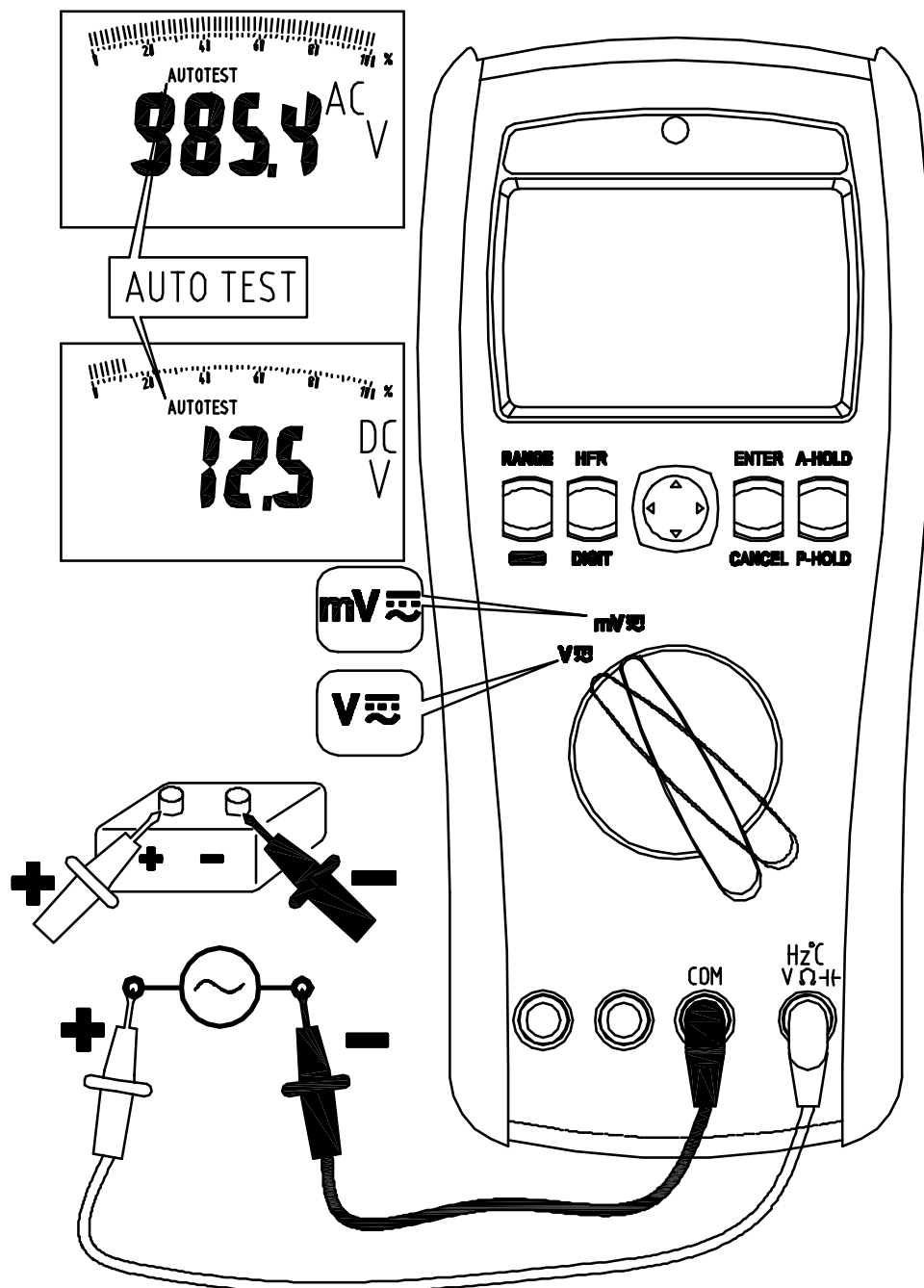

High Frequency Reject mode (HFR)

The HFR mode measures the voltage through a low pass filter to reject the high frequency. The -3dB point of the low pass filter is 800 Hz. The HFR mode can be used when the rotary switch is in the “V”, “mV” position. To use HFR mode, press the “HFR” button.

Measuring Resistance / Continuity / Diode Capacitance

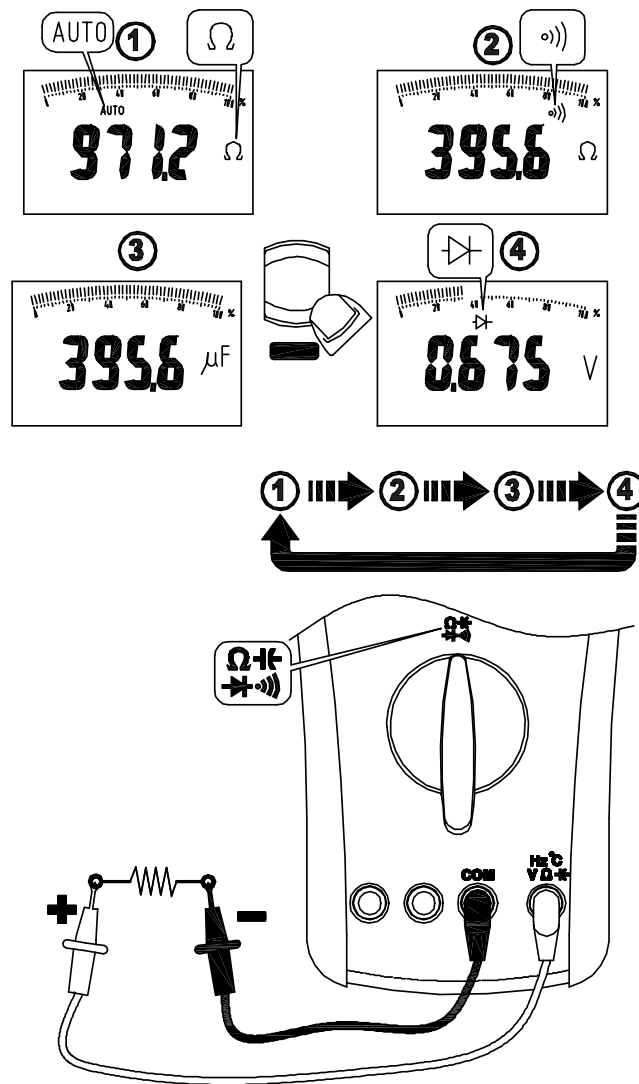

Testing Continuity

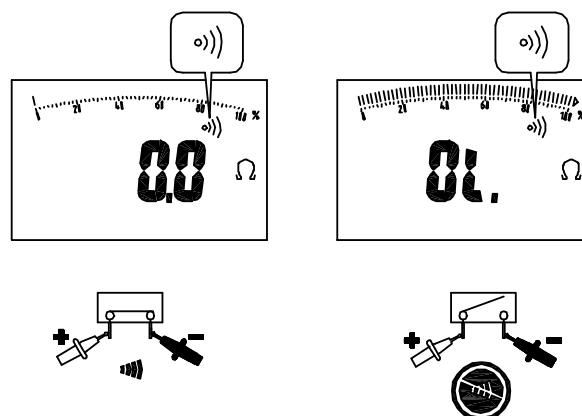

Diode Testing

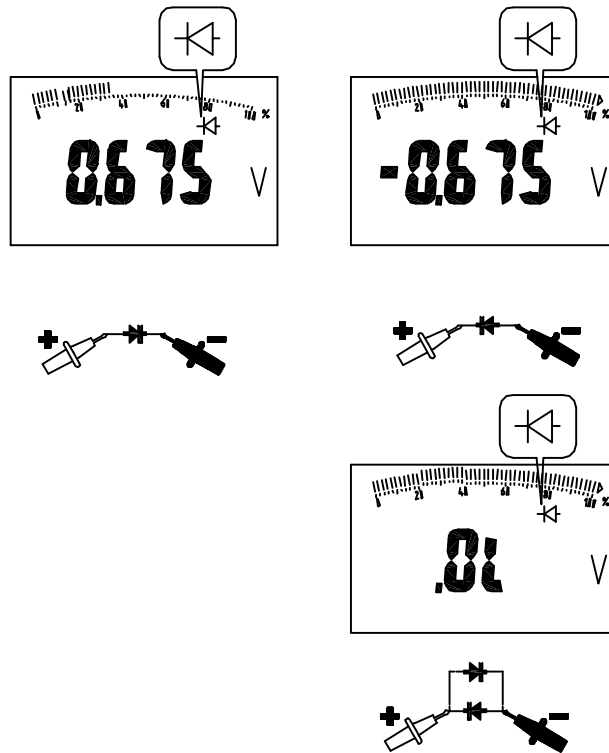

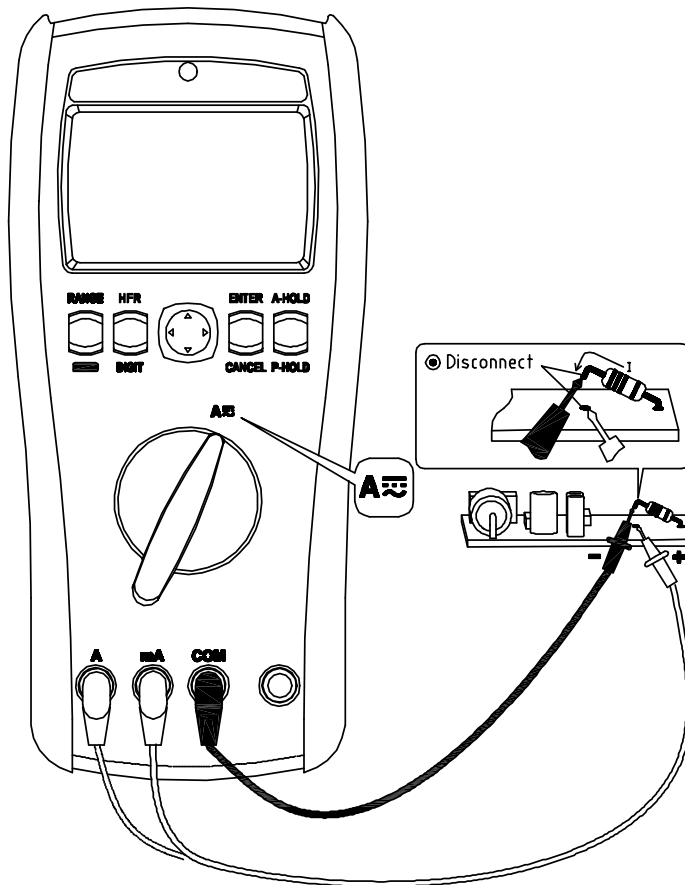

Measuring AC/DC Current

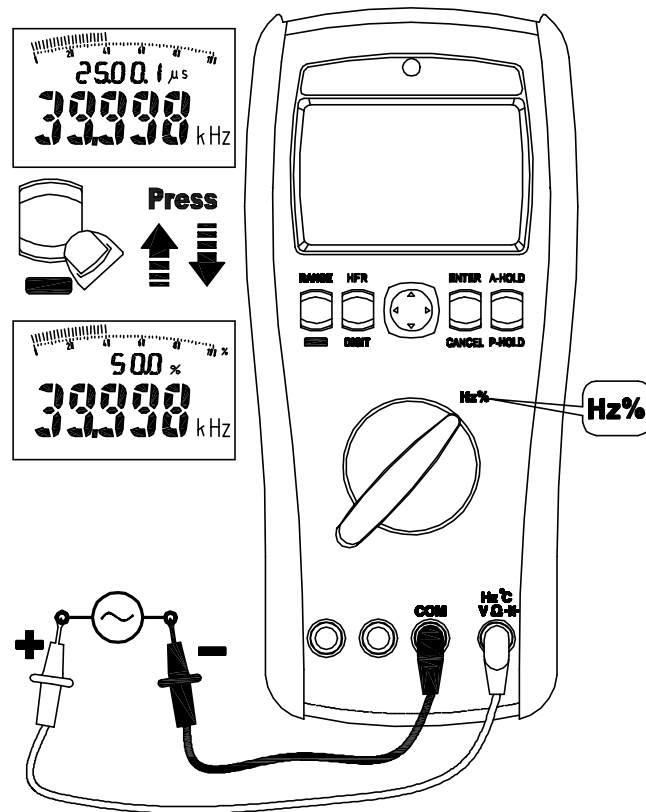

Press the blue button  to select the measuring function (AC/DC/AC+DC)

Measuring Frequency



Press the blue button  to select the measuring function. (Period/Duty)

Measuring Temperature °C / °F

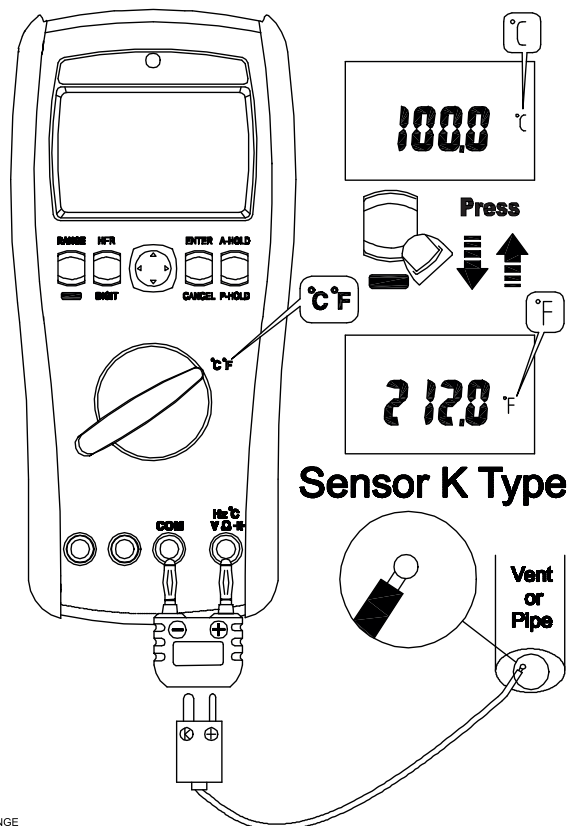

Press the blue button  to select the measuring function. ($^\circ\text{C} / ^\circ\text{F}$)

DIGIT:

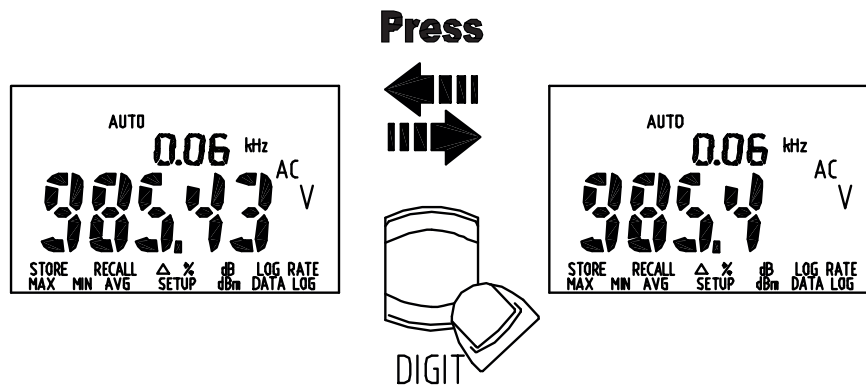

Press the “DIGIT” button to select the display digit.

AUTO HOLD

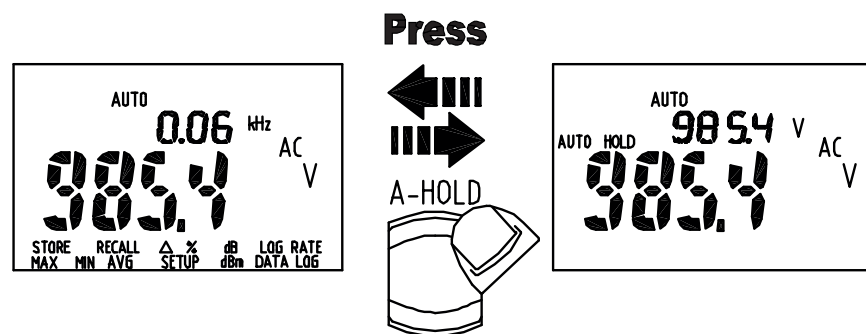

In the Auto Hold function, the instrument holds the reading and the current reading appears on the upper display. When the difference of the held value and the current value is above 20 counts, the instrument beeps and holds the new value. To use the Auto Hold mode, press the “A-HOLD” button.

Peak HOLD (ACV / ACA Only)

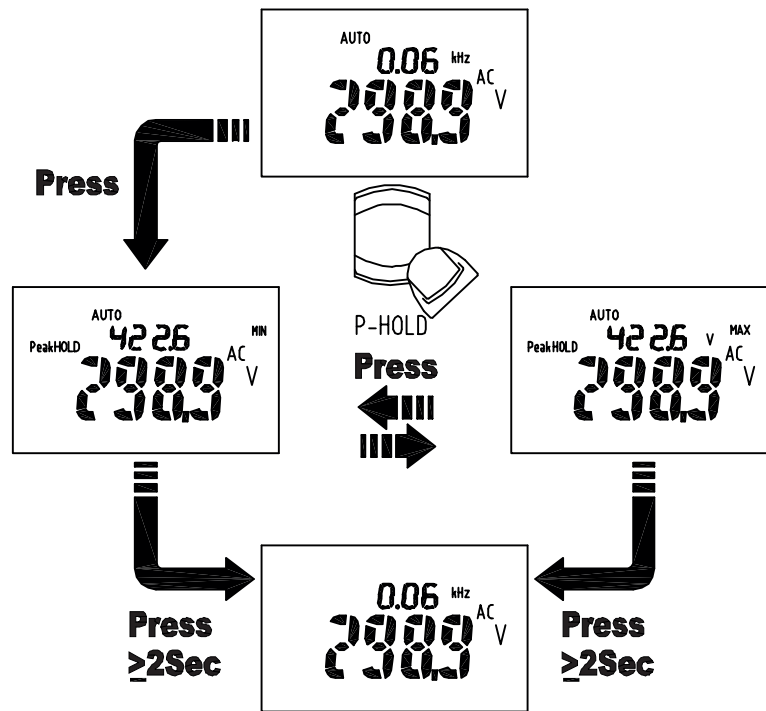

In the Peak Hold function, the instrument records the peak minimum value and the peak maximum value; when the inputs go below the recorded peak minimum value or above the recorded peak maximum value, the Instrument records the new value. To use the Peak HOLD mode, press the “P-HOLD” button.

Sub-Functions navigation option

Sub-Functions item

Navigation : Select the Sub-function item.

STORE	RECALL	Δ %	dB	LOG RATE
MAX	MIN	SETUP	dBm	DATA LOG

Buttons

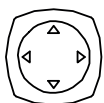

Navigation : Select the Sub-function item.

ENTER



ENTER : Enter the Sub-function.

CANCEL

CANCEL : Exit the function.

STORE and RECALL

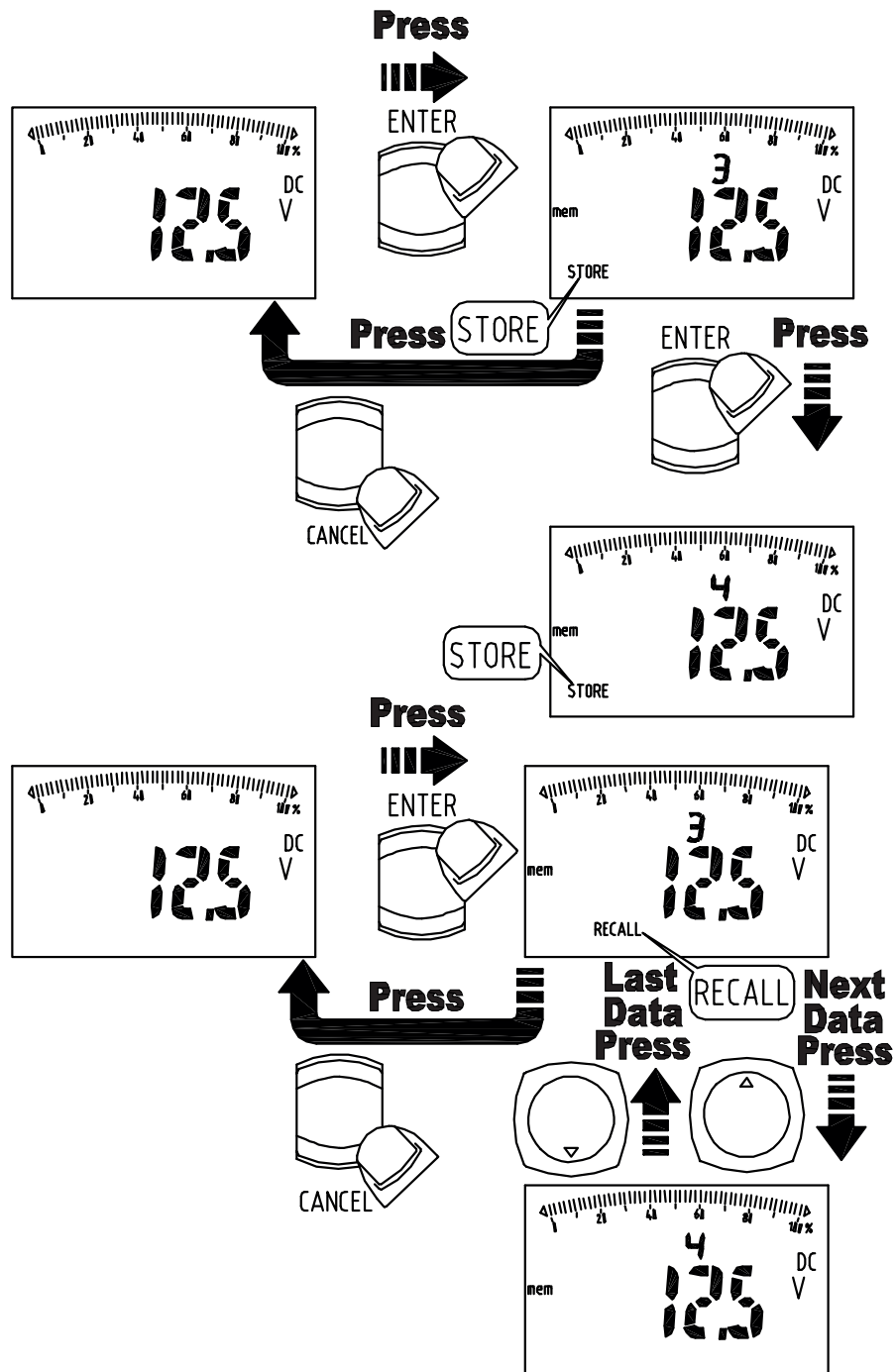

The store function records the input values to memory and recalls them from memory after. Up to 1000 readings can be stored and recalled.

MAX / MIN / AVG

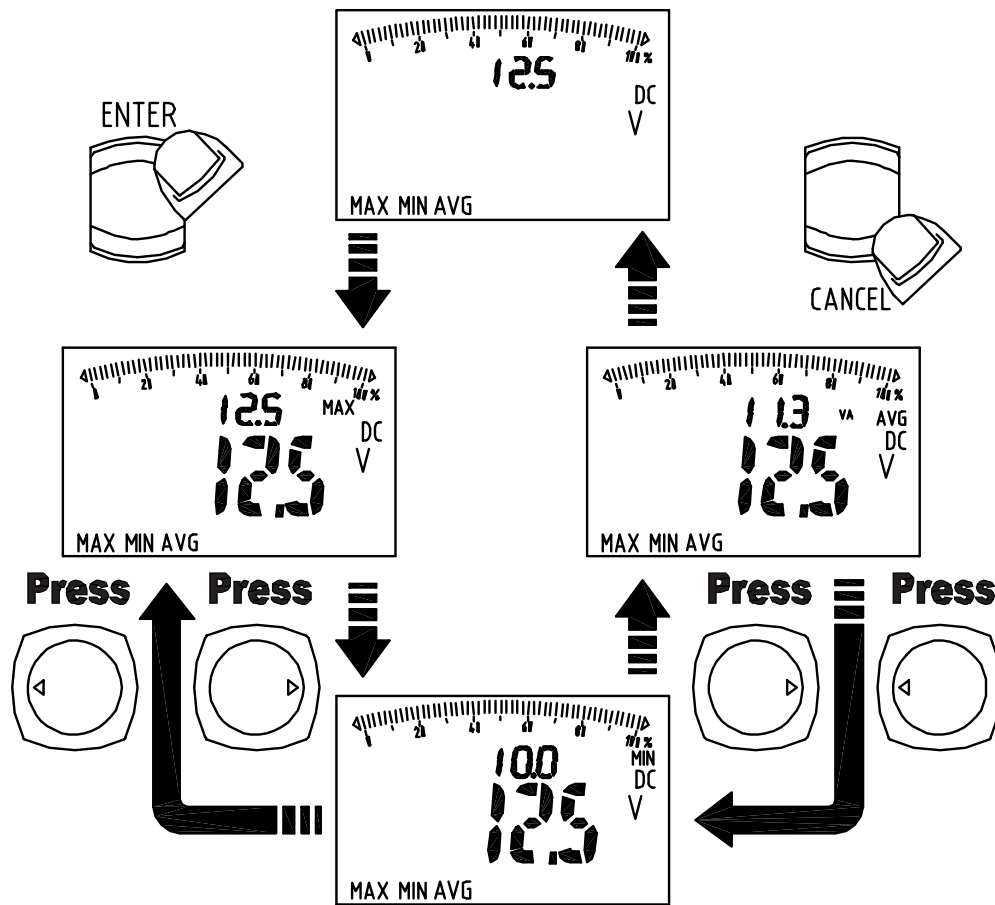

The MAX/MIN/AVG mode records the minimum and maximum input values. When the inputs go below the record minimum value or above the record maximum value, the Instrument records the new value. The MAX/MIN/AVG mode can also calculate the average of the maximum value and the minimum value.

dB and dBm (ACV / ACmV only)

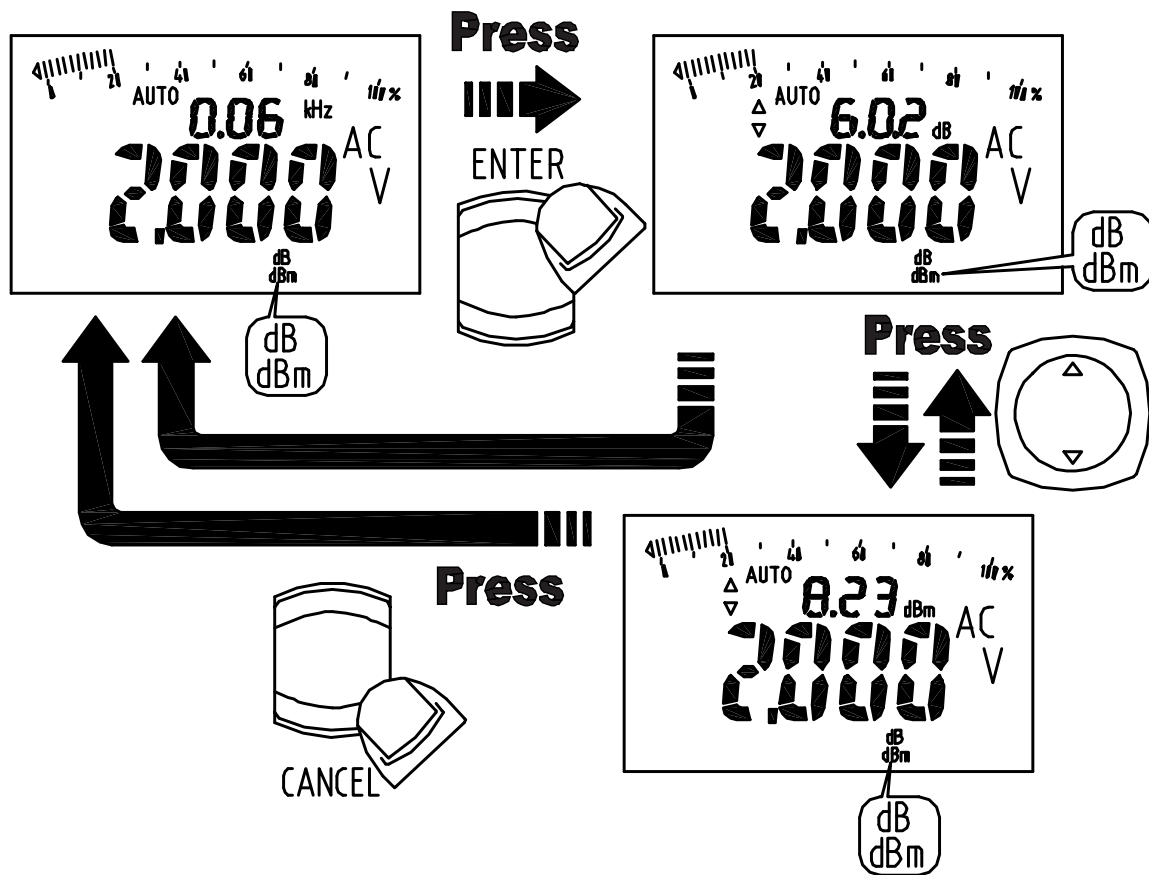

The decibel (dB) is a logarithmic unit of measurement that expresses the magnitude of a physical quantity relative to a specified or implied reference level. The dB and dBm are defined below.

$$\text{dB} = 20 \log \frac{V_{AC}}{1}$$

$$\text{dBm} = 20 \log \frac{V_{AC}}{0.7746}$$

Relative mode

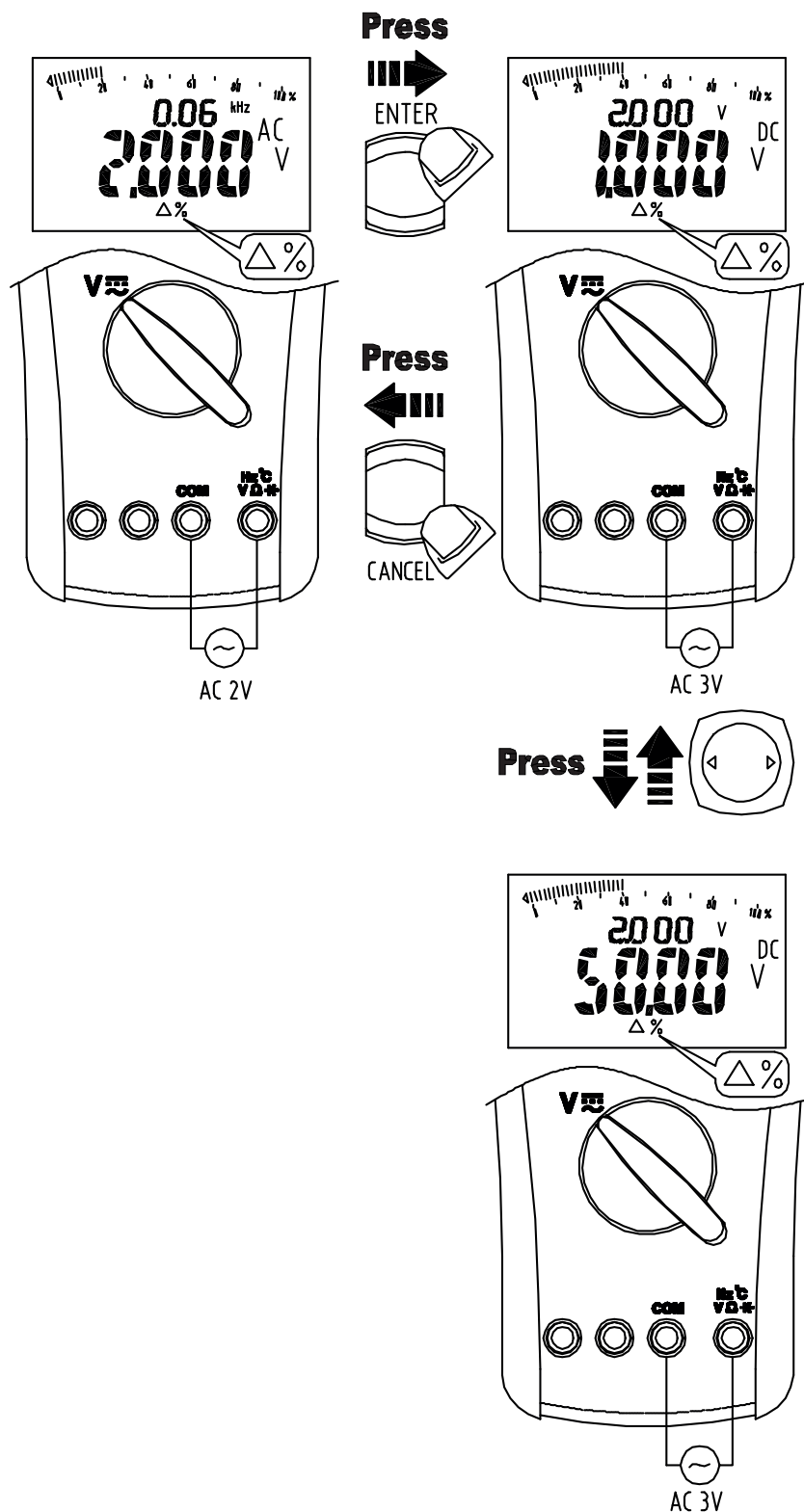

In the relative mode, the instrument records the current input value as the reference and appears on the upper display. For subsequent input values the instrument will calculate the difference (Δ) between the reference value and the input value or the difference percent (%) between the reference value and the input value.

SECTION 4 – SETUP OPTIONS

Press ▲ or ▼ changes the instrument setting.
Press “ENTER” to store the setting in memory.
Press ◀ or ▶ select the instrument setting item.
Press “CANCEL” to exit this function.

Beeper

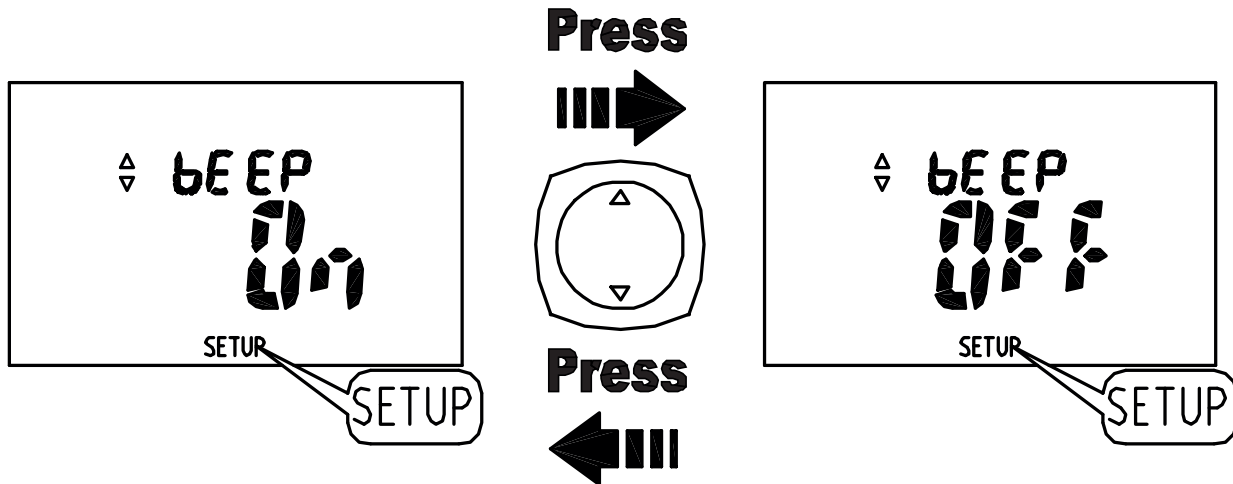

Set the beeper to be ON or OFF.

Auto Power Off (APO)

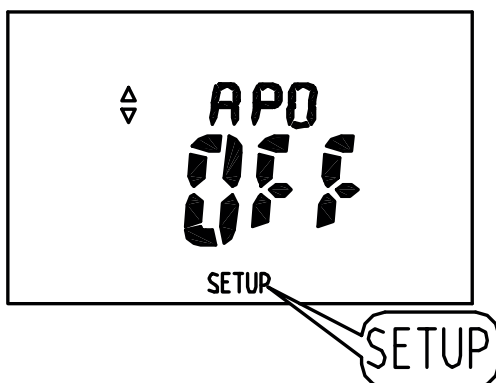

Setup the auto power off (APO) time from 1 to 60 minutes or off.

Back Light Auto OFF

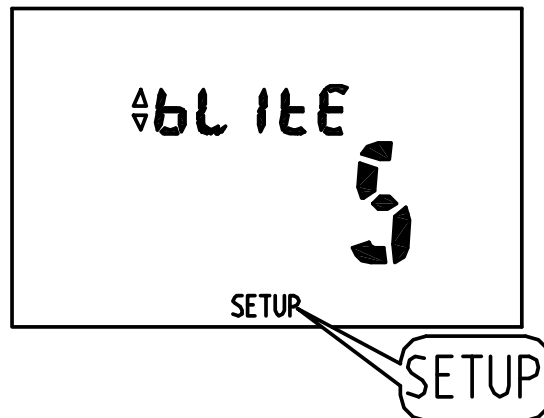

Setup the back light Auto OFF time from 1 to 60 minutes.

HAZARD

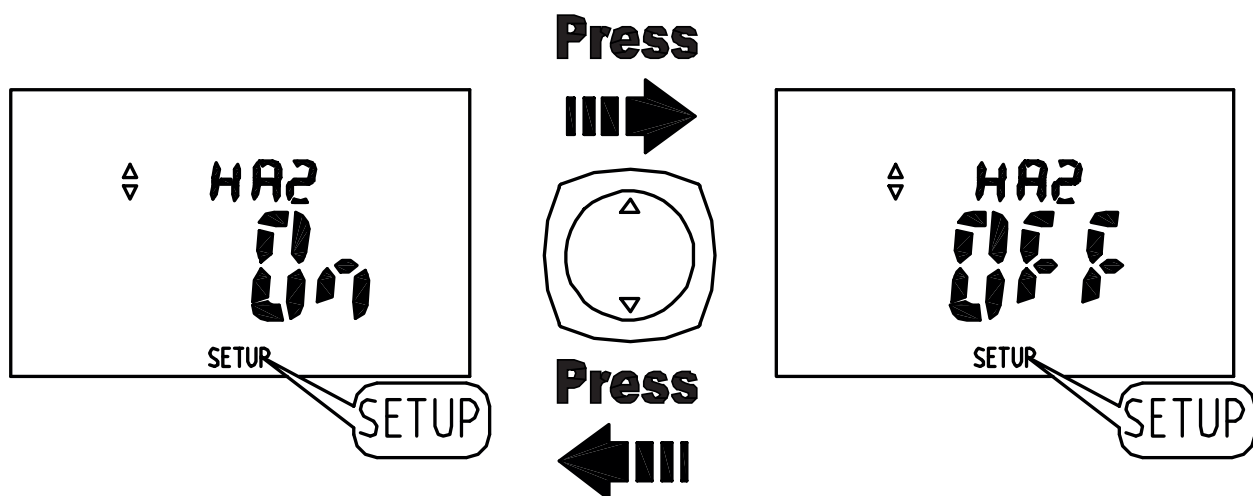

Set the hazardous voltage ($\geq 60V_{DC}$ or $\geq 30V_{AC}$) alarm beeper to ON or OFF.

RESET

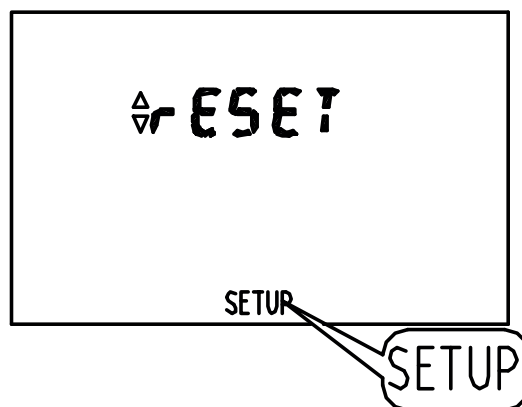

Reset all setup values to the factory default.

LOG RATE

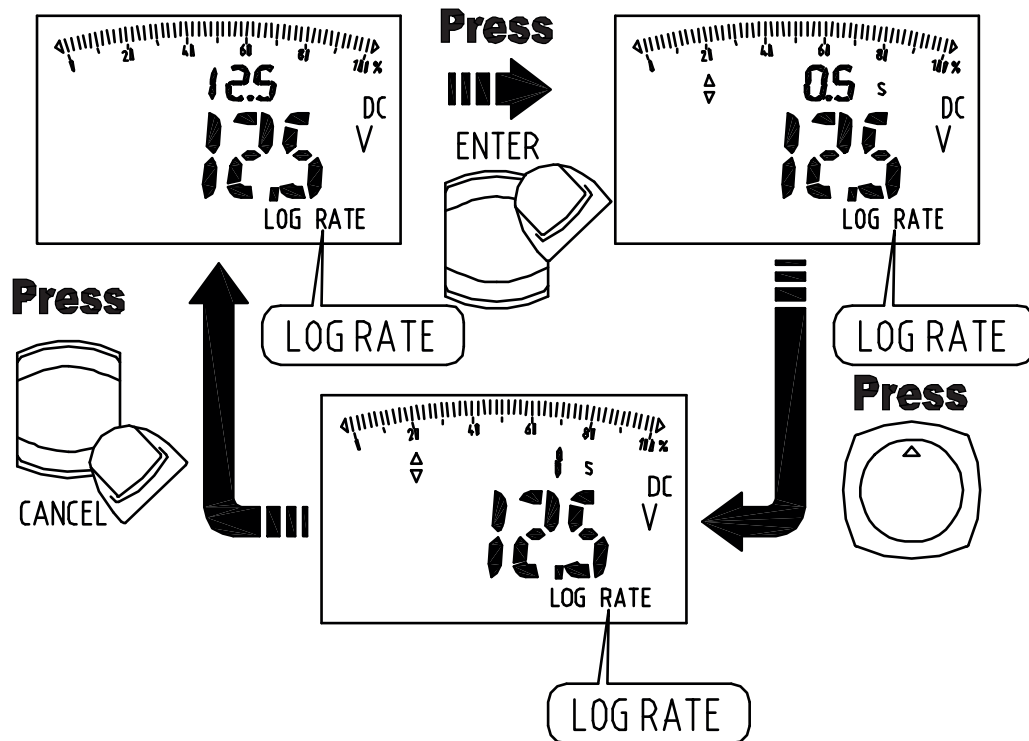

Setup the logging rate from 0.5 to 600 seconds.

DATALOG

The datalog mode records successive input values to memory and recalls them from memory afterwards. Up to 20000 values can be recorded in the memory.

Connection to a PC

1. Turn on the meter, and use the USB cable to connect the meter with PC.
2. Put the software CD into the CD-ROM of PC, then install the program and USB cable driver.
3. Run the program, the program will auto connect with the meter.

Auto Power Off

Wake up the instrument by switching the rotary switch or by pressing any button.

Auto Backlight

The backlight is automatically turned on in a dark environment.

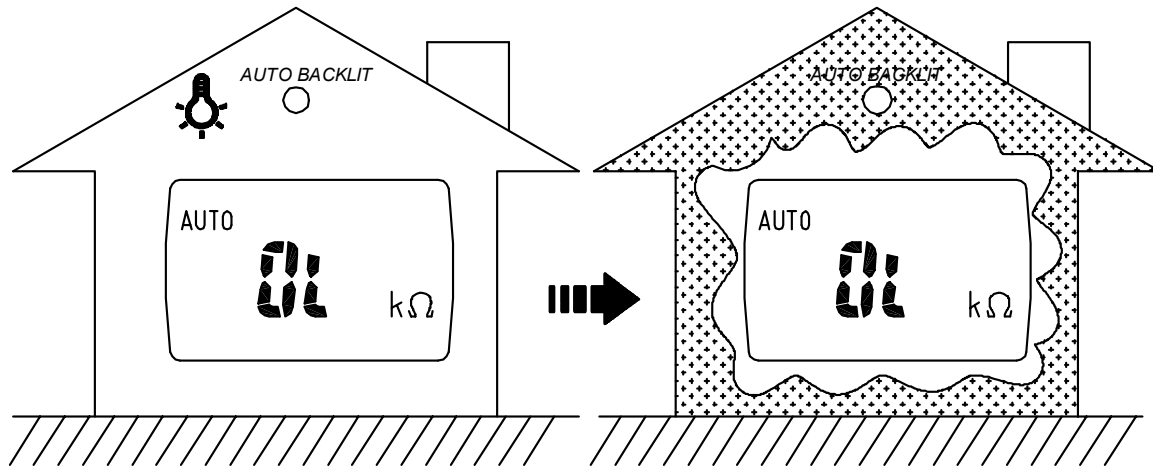

Buzzer

The instrument buzzer beeps once for every valid key-press, and beeps twice for every invalid key-press.

Power On Options

Press the following button while turning the Instrument on from the “OFF” position.

- “**CANCEL**” button : Clear all stored data
- “**RANGE**” button : Display LCD test frame
- “**FUNCTION**” button : Default °C / °F reading
- “**HFR**” button : Display firmware version
- “**A-HOLD**” button : Disable AUTO BACKLIGHT

SECTION 5 – BATTERY AND FUSE REPLACEMENT

CAUTION

The following safety information must be observed to ensure maximum personal safety during the operation of this instrument.

1. To avoid electric shock, disconnect the test leads before replacing the instrument fuse or batteries.
2. When replacing the tester batteries, do not mix batteries of different types or old and new batteries.
3. Check the battery polarity carefully when inserting the batteries.
4. Do not short-circuit used batteries, disassemble them, or throw them in a fire. Doing so may cause the batteries to explode.
5. Dispose of the used batteries in accordance with local regulations.

Refer to the following figure to replace the fuse and the batteries :

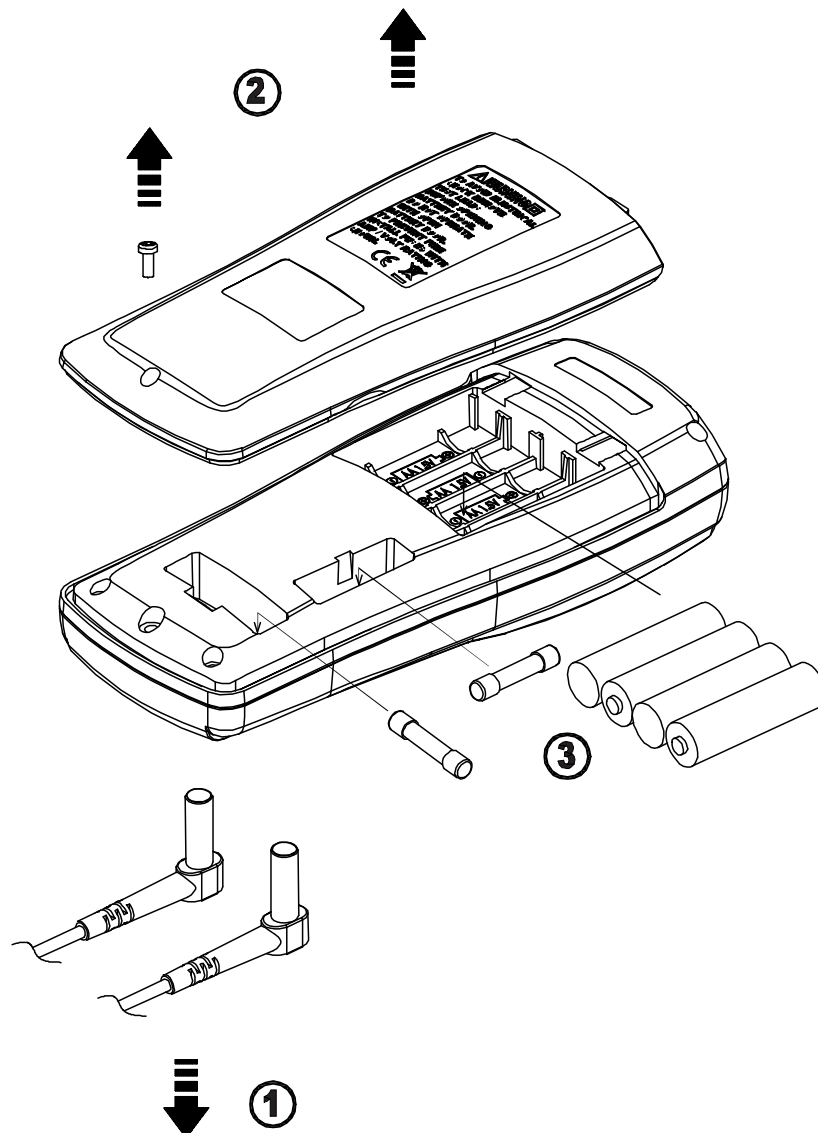

CAUTION

Use only fuses with the following fuse rating:

Fuse rating :

440mA, 1000V IR 10KA Fast acting fuse (size 35 x 10mm)

DMM-B-44/100 – 10,000A, 1000 VAC, unity power factor and
10,000A, 1000 VDC with time constant of 2.2ms

11A, 1000V IR 20KA Fast acting fuse (size 38 x 10mm)

DMM-B-11A – 20,000A, 1000 VAC, power factor ≤ 0.2 ; 20,000A,
1000 VDC, time constant ≥ 10 ms. (size 38 x 10mm)

Replace the batteries as soon as the low batteries indicator “” appears, to avoid false reading.

Replace with 4 x 1.5V AA alkaline batteries.

SECTION 6 - SPECIFICATIONS

General Specifications

Maximum voltage applied to any terminal :

1000 V ac rms or dc.

Display : 4000/40000 counts for IDM503.

10000/100000 counts for IDM505.

Polarity Indication : Automatic, positive implied, negative indicated.

Overrange Indication : “OL”

Batteries Life : 100 hours typical

Low Batteries Indication : “” is displayed when the battery voltage drops below the operating voltage.

Low battery voltage : Approx. 4.5V

Auto Power Off : Default 30 minutes.

Operating Ambient : **Non-condensing** $\leq 10^{\circ}\text{C}$,
11 $^{\circ}\text{C}$ ~ 30 $^{\circ}\text{C}$ ($\leq 80\%$ RH),
30 $^{\circ}\text{C}$ ~ 40 $^{\circ}\text{C}$ ($\leq 75\%$ RH),
40 $^{\circ}\text{C}$ ~ 50 $^{\circ}\text{C}$ ($\leq 45\%$ RH)

Storage Temperature : -20 $^{\circ}\text{C}$ to 60 $^{\circ}\text{C}$, 0 to 80% RH (batteries not fitted)

Temperature Coefficient : 0.15 x (Spec.Accy) / $^{\circ}\text{C}$, < 18 $^{\circ}\text{C}$ or > 28 $^{\circ}\text{C}$.

Measure : Samples 3 times per second normal.

Altitude : 2000m

Safety : Complies with EN61010-1, UL61010-1, IEC 61010-1, CAT. IV 600V, CAT.III 1000V

Measurement Category	Application
I	Measurements on circuits not directly connected to mains. Examples include: Measurements on battery powered equipment and specially protected (internal) mains-derived circuits.
II	Measurements on circuits directly connected to the low voltage installation. Examples include: Household appliances, portable tools and similar equipment.
III	Measurements performed in the building installation. Examples include measurements on distribution boards, junction boxes, socket-outlets and wiring and cables in the fixed installation.
IV	Measurements performed at the source of the low-voltage installation. Examples include measurements on primary overcurrent protection devices and electricity Instruments

Weight : (630g) including battery.

Dimensions (W x H x D) : 95mm x 207mm x 52mm with holster.

Accessories Supplied: 4 x 1.5V AA batteries (installed), Test lead set , type K thermocouple bead sensor , PC software on CD ROM and user manual.

Power Requirements : 1.5V x 4 IEC LR6 or AA size.

Pollution degree : 2

EMC : EN 61326-1

Shock vibration : Sinusoidal vibration per MIL-T- 28800E (5 ~ 55 Hz, 3g maximum).

Drop Protection : 4 feet drop to hardwood on concrete floor.

Indoor use only.

Electrical Specifications

Accuracy is \pm (% reading + number of digits) at $23^{\circ}\text{C} \pm 5^{\circ}\text{C} < 80\%RH$.

(1) Voltage

IDM503		
Range	Frequency	Accuracy
40.000mV _{DC}	—	$\pm (0.040\% + 40d)$
400.00mV _{DC}		$\pm (0.035\% + 20d)$
4.0000V _{DC} 40.000V _{DC} 400.00V _{DC} 1000.0V _{DC}		$\pm (0.03\% + 20d)$
40.000mV _{AC} 400.00mV _{AC}	40Hz ~ 65Hz	$\pm (1.00\% + 50d)^{[1]}$
	66Hz ~ 1KHz	$\pm (3.00\% + 50d)^{[1]}$
	1.01KHz ~ 3KHz	$\pm (5.00\% + 50d)^{[2]}$
4.0000V _{AC} 40.000V _{AC} 400.00V _{AC} 1000.0V _{AC}	40Hz ~ 45Hz	$\pm (1.50\% + 50d)^{[1]}$
	46Hz ~ 65Hz	$\pm (0.70\% + 50d)^{[1]}$
	66Hz ~ 1KHz	$\pm (1.50\% + 50d)^{[1][4]}$
4.0000V _{AC} 40.000V _{AC}	1.01KHz ~ 10KHz	$\pm (3.00\% + 50d)^{[2]}$
	10.01KHz ~ 50KHz	$\pm (5.00\% + 50d)^{[3]}$
	50.01KHz ~ 100KHz	$\pm (10.0\% + 50d)^{[3][5]}$
<p>[1] Below 5% of range, add 70 counts. Below 45Hz, < 50dgt rolling.</p> <p>[2] Below 5% of range, add 150 counts.</p> <p>[3] Below 5% of range, add 350 counts.</p> <p>[4] At 1000.0VAC, the accuracy is $\pm (10.0\% + 50d)$.</p> <p>[5] At 40.000VAC, the accuracy is $\pm (15.0\% + 50d)$.</p>		

IDM505		
Range	Frequency	Accuracy
100.000mV _{DC}	—	± (0.025% + 40d)
1000.00mV _{DC}		± (0.020% + 20d)
10.0000V _{DC} 100.000V _{DC} 1000.00V _{DC}		± (0.015% + 20d)
100.000mV _{AC} 1000.00mV _{AC}	40Hz ~ 65Hz	± (0.70% + 50d) ^[1]
	66Hz ~ 1KHz	± (1.50% + 50d) ^[1]
	1.01KHz ~ 3KHz	± (3.00% + 50d) ^[2]
10.0000V _{AC} 100.000V _{AC} 1000.00V _{AC}	40Hz ~ 45Hz	± (1.00% + 50d) ^[1]
	46Hz ~ 65Hz	± (0.40% + 50d) ^[1]
	66Hz ~ 1KHz	± (1.00% + 50d) ^[1]
10.0000V _{AC} 100.000V _{AC}	1.01KHz ~ 10KHz	± (2.00% + 50d) ^[1]
	10.01KHz ~ 20KHz	± (3.00% + 50d) ^[2]
	20.01KHz ~ 50KHz	± (5.00% + 50d) ^[3]
	50.01KHz ~ 100KHz	± (10.0% + 50d) ^{[3][4]}
<p>[1] Below 5% of range, add 70 counts. Below 45Hz, < 50dgt rolling.</p> <p>[2] Below 5% of range, add 150 counts.[4] At 1000.0VAC, the accuracy is ± (10.0% + 50d).</p> <p>[3] Below 5% of range, add 350 counts.</p> <p>[4] At 100.000VAC, the accuracy is ± (15.0% + 50d).</p>		

Input Protection : 1000V_{DC} or 1000V_{AC} rms

Bandwidth : 40Hz ~ 100KHz

Minimum Resolution : 1μV in the 100mV range and the 40mV range.

Input Impedance : 10MΩ, <100pF

**CMRR / NMRR : (Common Mode Rejection Ratio)
(Normal Mode Rejection Ratio)**

VAC : CMRR > 60dB at DC, 50Hz / 60Hz

VDC : CMRR > 100dB at DC, 50Hz / 60Hz

NMRR > 50dB at DC, 50Hz / 60Hz

AC Conversion Type : AC conversions are ac-coupled, true rms responding, calibrated to the sine wave input.

For non-sine wave add the following Crest Factor corrections :

For Crest Factor of 1.4 to 2.0, add 1.0% to accuracy.

For Crest Factor of 2.0 to 2.5, add 2.5% to accuracy.

For Crest Factor of 2.5 to 3.0, add 4.0% to accuracy.

AC+DC Accuracy : Add 1.0% to accuracy.

HFR Accuracy : Add 1.0% to accuracy at 40Hz ~ 400Hz.

The cut-off frequency of the High Frequency Reject : 800Hz (-3dB)

dB/dBm : ± 60dBm

Note : For best measurements, use the with REL Δ function to compensate for offsets.

(2) Current

IDM503		
Range	Frequency	Accuracy
40.000mA _{DC} 400.00mA _{DC}	—	± (0.2% + 40d)
4.0000mA _{DC} 10.000mA _{DC}		± (0.2% + 80d)
40.000A _{AC} 400.00A _{AC}	40Hz ~ 65Hz	± (0.8% + 80d) ^[1]
4.0000A _{DC} 10.000A _{AC}	66Hz ~ 1KHz	± (3.0% + 80d) ^[1]

IDM505		
Range	Frequency	Accuracy
10.0000mA _{DC} 100.000mA _{DC}	—	± (0.1% + 40d)
10.0000mA _{DC}		± (0.1% + 80d)
10.0000A _{AC} 100.000A _{AC}	40Hz ~ 65Hz	± (0.7% + 80d) ^[1]
10.0000A _{AC}	66Hz ~ 1KHz	± (2.0% + 80d) ^[1]
[1] Below 5% of range, add 70 counts. Below 45Hz, < 50dgt rolling.		

Input Protection : Protected by high energy fuse.

mA input: 440mA, 1000V IR 10KA Fast acting fuse.

DMM-B-44/100 – 10,000A, 1000 VAC, unity power factor and
10,000A, 1000 VDC with time constant of 2.2ms

A input: 11A, 1000V IR 20KA Fast acting fuse for A input.

DMM-B-11A – 20,000A, 1000 VAC, power factor ≤ 0.2;
20,000A, 1000 VDC, time constant ≥ 10ms.

Bandwidth : 40Hz ~ 1KHz

Minimum Resolution :

1µA in the 40mA range for IDM503,
0.1µA in the 10mA range for IDM505.

Maximum Measuring Time :

3 minutes at “A” input, 10 minutes at “mA” input.
Rest time 20 minutes minimum.

AC Conversion Type : Conversion type and additional
specification are same as voltage.

(3) Peak HOLD

Specified accuracy ± (3.0% + 100d) up to 50000 count (full range).

(3) Resistance

IDM503		
Range	Resolution	Accuracy
400.00Ω	0.01Ω	± (0.2% + 30d)
4.0000KΩ	0.1Ω	
40.000KΩ	1Ω	
400.00KΩ	10Ω	± (0.3% + 30d)
4.0000MΩ	100Ω	± (1.0% + 30d) ^[1]
40.00MΩ	10KΩ	± (1.5% + 30d) ^[1]

IDM505		
Range	Resolution	Accuracy
1000.00Ω	0.01Ω	± (0.05% + 30d)
10.0000KΩ	0.1Ω	± (0.025% + 30d)
100.000KΩ	1Ω	
1000.00KΩ	10Ω	± (0.3% + 30d)
10.0000MΩ	100Ω	± (1.0% + 30d) ^[1]
40.00MΩ	10KΩ	± (1.5% + 30d) ^[1]

[1] < 100dgt rolling.

Input Protection : 1000VDC or 1000VAC rms

Maximum Open Circuit Voltage : Approximate 2.5V

Maximum Test Current : Approximate 0.1mA

Note : For best measurements, use the with REL Δ function to compensate for offsets.

(4) Continuity Checks

IDM503		
Range	Resolution	Accuracy
400.0Ω	0.1Ω	± (0.2% + 3d)

IDM505		
Range	Resolution	Accuracy
1000.0Ω	0.1Ω	± (0.05% + 3d)

Input Protection : 1000VDC or 1000VAC rms
Maximum Open Circuit Voltage : Approximate 2.5V
Maximum Test Current : Approximate 0.1mA
Continuity Threshold : Approximate 50Ω
Continuity Indicator : 2kHz Tone Buzzer

(5) Diode Test

IDM503		
Range	Resolution	Accuracy
2.000V	1mV	± (1.5% + 2d)

IDM505		
Range	Resolution	Accuracy
0.400V ~ 0.800V	1mV	± (1.5% + 2d)

Input Protection : 1000VDC or 1000VAC rms
Maximum Open Circuit Voltage : Approximate ± 2.5V
Maximum Test Current : Approximate ± 0.5mA

(6) Capacitance

IDM503			
Range	Resolution	Accuracy	Measuring Time
4.000nF	1pF	Unspecified	0.7sec
40.00nF	10pF	$\pm (1.2\% + 20d)$	
400.0nF	100pF	$\pm (0.9\% + 2d)$	
4.000 μ F	1nF		
40.00 μ F	10nF		
400.0 μ F	100nF		
4.000mF	1 μ F	$\pm (1.2\% + 20d)$	3.75sec
40.00mF	10 μ F	$\pm (1.2\% + 40d)$ ^[1]	7.5sec

IDM505			
Range	Resolution	Accuracy	Measuring Time
4.000nF	1pF	Unspecified	0.7sec
40.00nF	10pF	$\pm (1.2\% + 20d)$	
400.0nF	100pF	$\pm (0.8\% + 2d)$	
4.000 μ F	1nF		
40.00 μ F	10nF		
400.0 μ F	100nF		
4.000mF	1 μ F	$\pm (1.2\% + 20d)$	3.75sec
40.00mF	10 μ F	$\pm (1.2\% + 40d)$ ^[1]	7.5sec

[1] < 50dgt rolling.

Input Protection : 1000V_{DC} or 1000V_{AC} rms

Note : For best measurements, use the with REL Δ function to compensate for offsets.

(7) Frequency Counter

IDM503/505			
Range	Resolution	Accuracy	Sensitivity
40.000Hz	0.001Hz	$\pm (0.002\% + 10d)$	1V _{P-P}
400.00Hz	0.01Hz		
4.0000KHz	0.1Hz		
40.000KHz	1Hz		
400.00KHz	10Hz		5V _{P-P}
4.0000MHz	100Hz		

Input Protection : 1000V_{DC} or 1000V_{AC} rms

Min Frequency : 5Hz

(8) Duty Factor

IDM503/505			
Range	Resolution	Accuracy	Sensitivity
20.0% ~ 80.0%	0.1%	$\pm (0.1\% + 10d)$	5V _{P-P}

Input Protection : 1000VDC or 1000VAC rms

Sense Wave : Square Wave (5Hz ~ 10KHz)

(9) Temperature

IDM503/505		
Range	Resolution	Accuracy
-200.0°C ~ 10.0°C	0.1°C	$\pm (1.0\% + 2^\circ\text{C})$
10.1°C ~ 1200.0°C		$\pm (1.0\% + 1^\circ\text{C})$
-328.0°F ~ 50.0°F	0.1°F	$\pm (1.0\% + 4^\circ\text{F})$
50.1°F ~ 2192.0°F		$\pm (1.0\% + 2^\circ\text{F})$

Input Protection : 1000V_{DC} or 1000V_{AC} rms

Africa

RS Components SA

P.O. Box 12182,
Vorna Valley, 1686
20 Indianapolis Street,
Kyalami Business Park,
Kyalami, Midrand
South Africa

www.rs-components.com

Asia

RS Components Pte Ltd.

31 Tech Park Crescent
Singapore 638040

www.rs-components.com

China

RS Components Ltd.

Suite 23 A-C
East Sea Business Centre
Phase 2
No. 618 Yan'an Eastern Road
Shanghai, 200001
China

www.rs-components.com

Europe

RS Components Ltd.

PO Box 99, Corby,
Northants.
NN17 9RS
United Kingdom

www.rs-components.com

Japan

RS Components Ltd.

West Tower (12th Floor),
Yokohama Business Park,
134 Godocho, Hodogaya,
Yokohama, Kanagawa 240-0005
Japan

www.rs-components.com

U.S.A

Allied Electronics

7151 Jack Newell Blvd. S.
Fort Worth,
Texas 76118
U.S.A.

www.alliedelec.com

South America

RS Componentes Limitada

Av. Pdte. Eduardo Frei M. 6001-71
Centro Empresas El Cortijo
Conchali, Santiago, Chile

www.rs-components.com