

# 80 Series V Multimeter Quick Reference Guide

⚠ See Users Manual for "Safety Information" and complete operating information.

## Fuse Test

## Test Lead Alert

🎵 + LEAD = 🔌 OK

🎵 + LEAD = ⚠

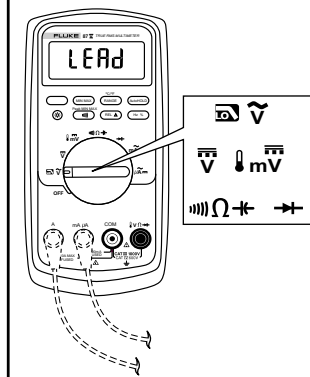
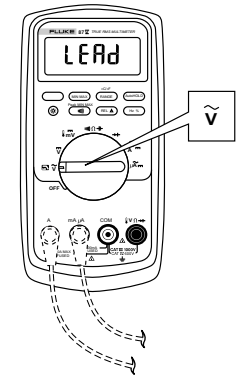

## Voltage $\tilde{V}$ $\bar{V}$ mV

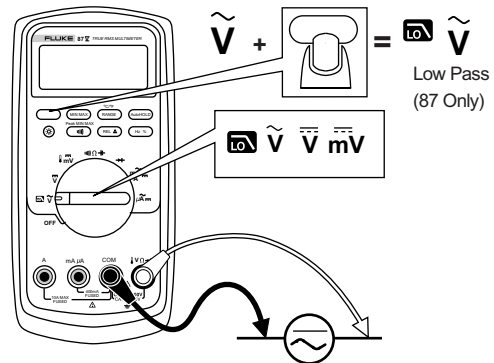

## Temperature (87 Only) ↓

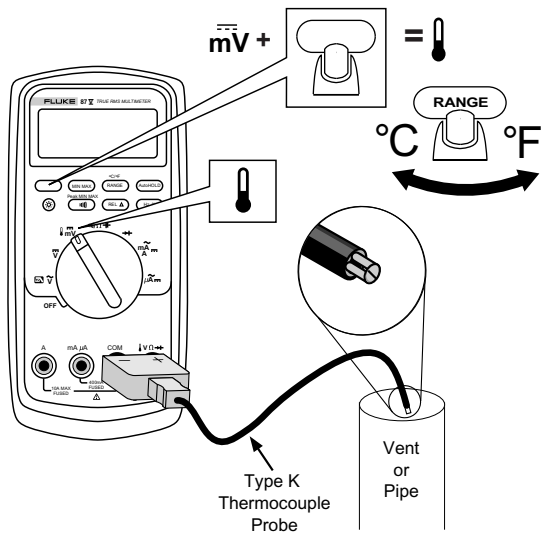

## Resistance $\Omega$

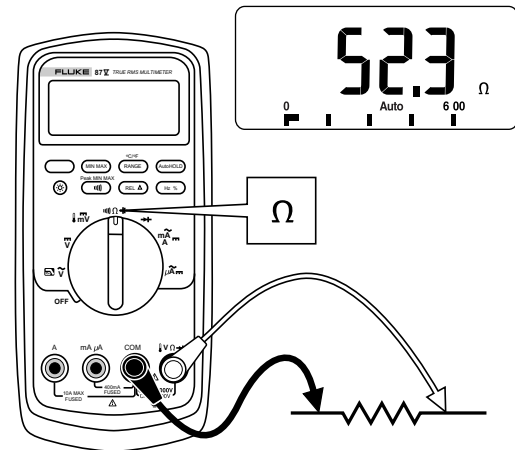

## Conductance nS

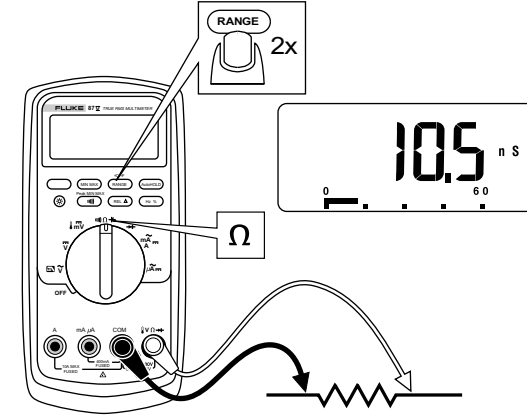

## Continuity 🎵

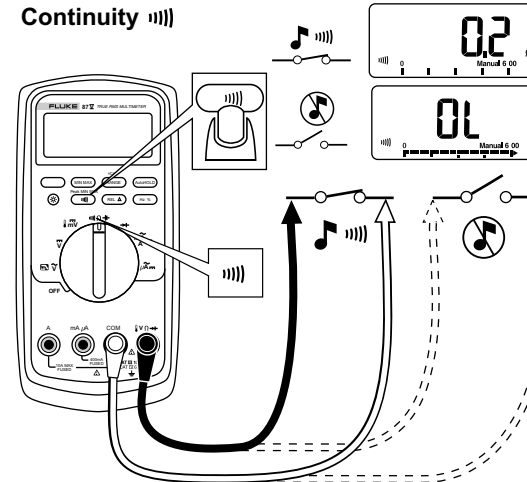

## Capacitance $\bar{C}$

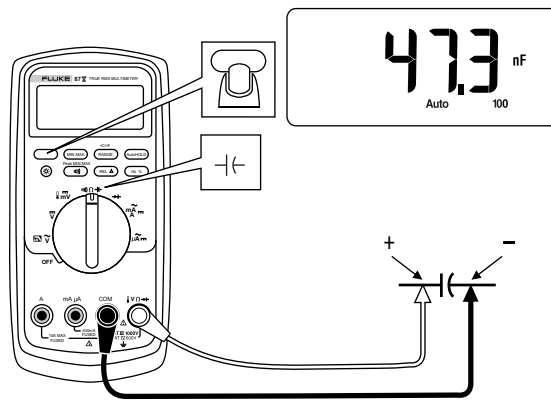

## Current $\tilde{A}$ , $\bar{A}$ , $\mu\tilde{A}$ , mA, A, $\mu A$

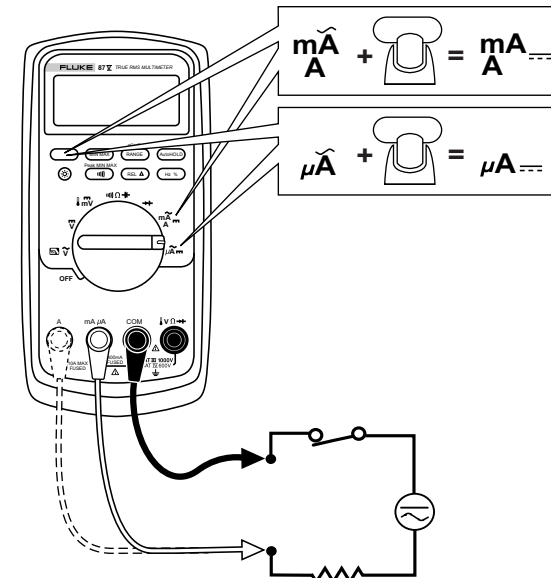

### Diode Test →

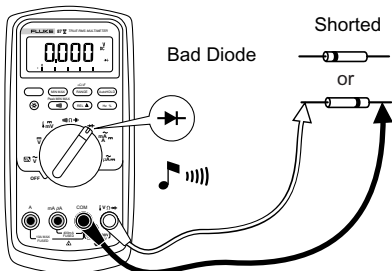
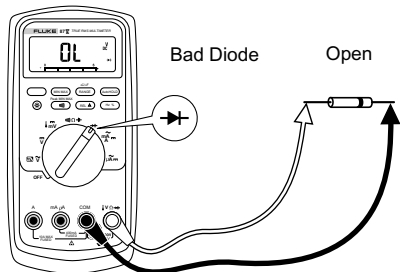
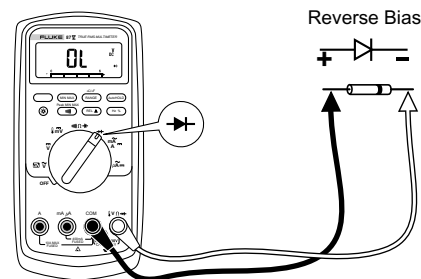
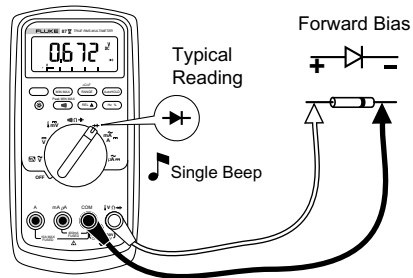

### Frequency Hz

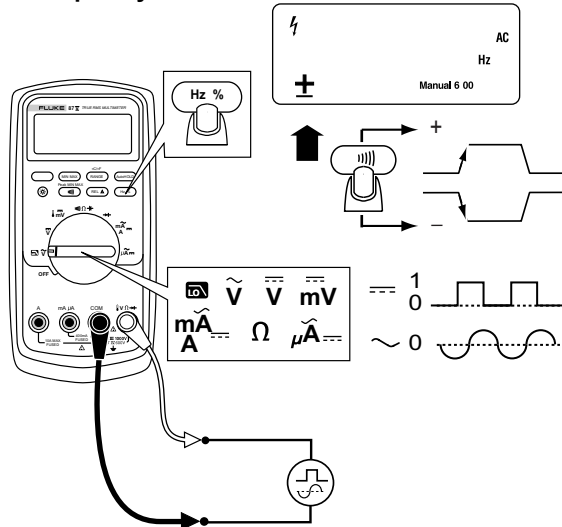

### Duty Cycle %

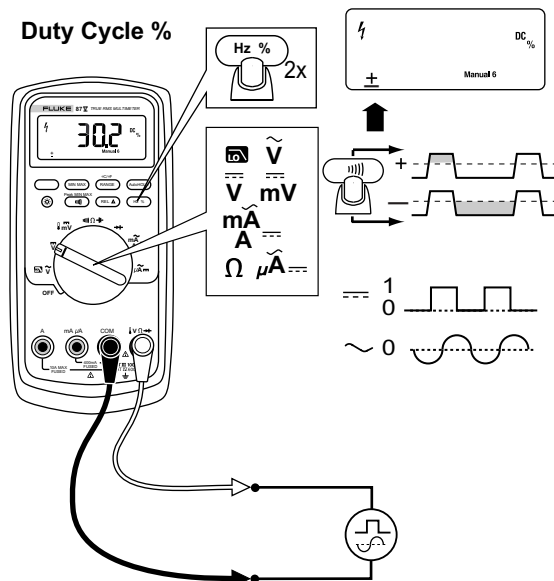

### Min, Max, Average MIN MAX

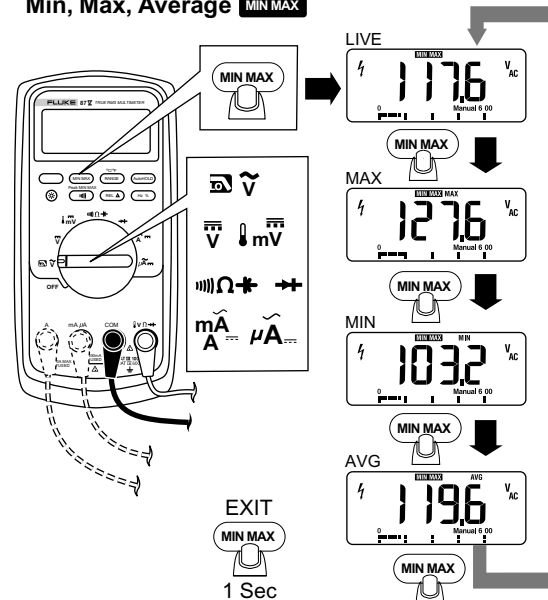

### AutoHOLD HOLD

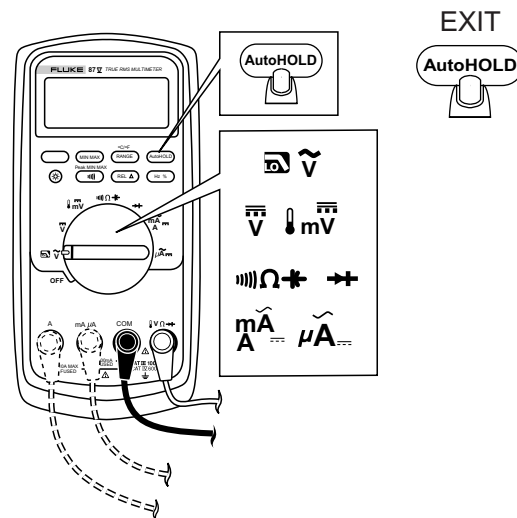

### Relative Δ

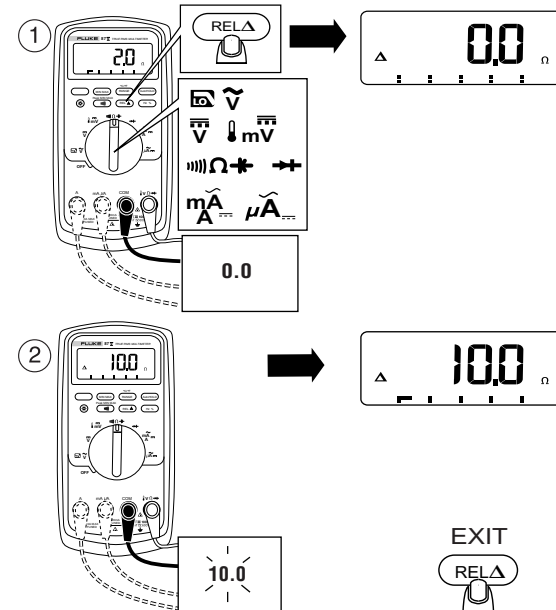

### Hi Res Mode (87 Only)

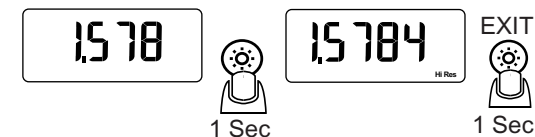

### ToolPak

